



2024





	7
	7
VIP	7
	8
	8
	8
	8
SINOMEMB®	SNLE	16
	16
	17
	17
	17
	17
	19
	19
	19
	19
	19
	19
	20
	22
	22
	22
	22
	22
	23
	23
	25
	25
	25
	25



.....25

.....26

..... 27

.....27

..... 27

.....27

.....27

.....27

.....28

.....29

.....29

.....29

.....29

.....30

.....31

.....31

.....31

.....31

.....32

.....32

® 34

.....34

.....34

.....34

.....34

.....35

.....35

.....37

.....37

.....37

.....38

.....38

.....39

.....42

.....42

.....42

.....42

.....43



.....45

.....45

.....45

.....45

.....45

.....46

.....47

.....47

.....49

.....49

.....50

.....52

.....52

.....56

.....58

.....61

.....63

.....63

.....63

.....64

.....65

.....69

.....72

.....72

.....75

.....77

.....81

.....83

.....84

.....86

.....87



.....	87
.....	87
.....	90
.....	91
.....	92
.....	94
.....	96
.....	96
.....	99
.....	102
SINOMEMB®	
.....	104
.....	104



I. SINOMEMB®

VIP



II. SINOMEMB®



III. SINOMEMB®

IV. SINOMEMB®



VI. SINOMEMB®

SNBW-8040-FR400/34

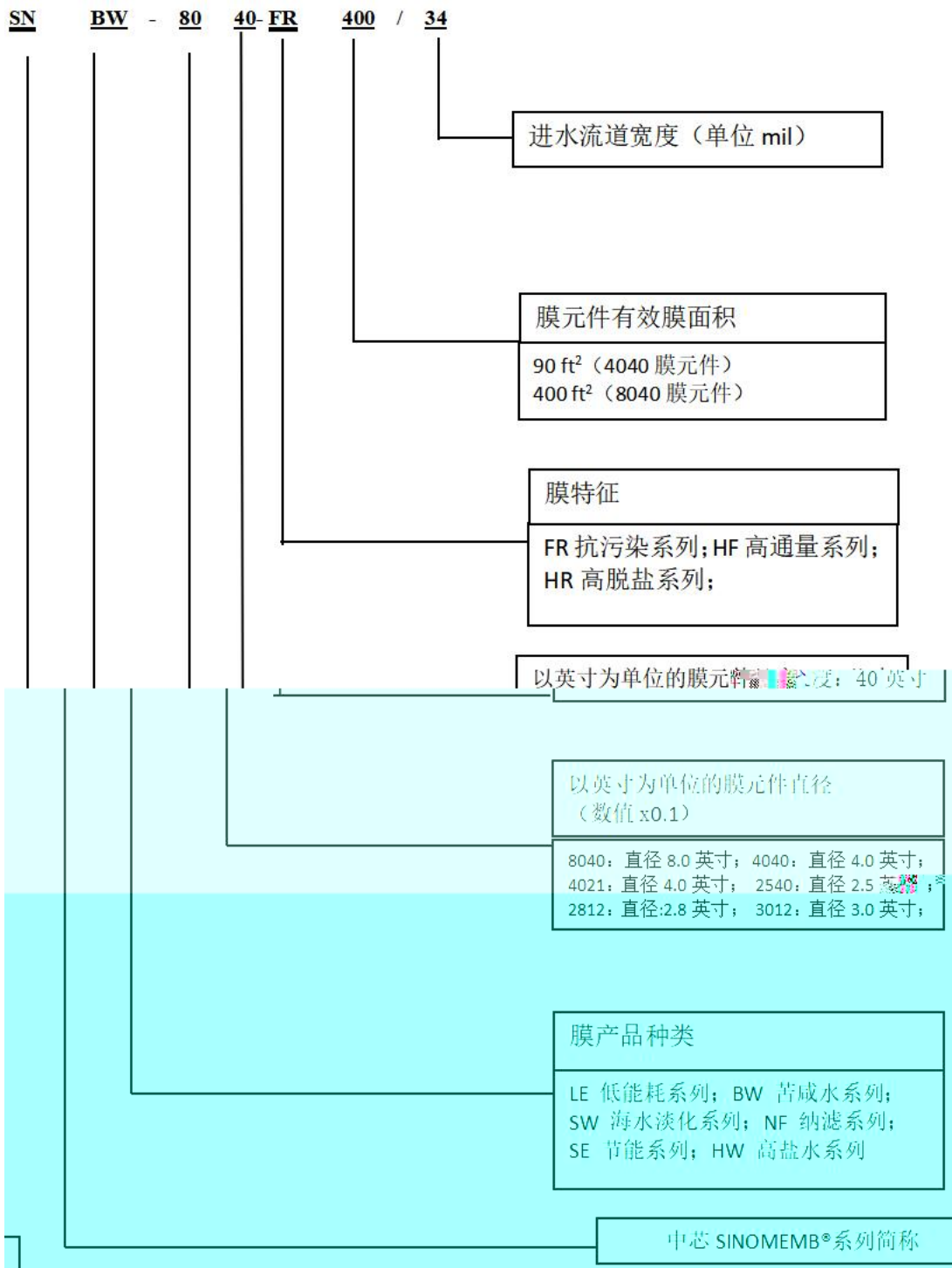



VII. SINOMEMB®

SINOMEMB®

SN-BW	
SN-BW-HF	
SN-BW-Por	
SN-BW-FR	
SN-BW-XFR	
SN-LE	
SN-LE-HF	
SN-SE	
SN-NF90	
SN-NF270	
SN-HW	
SN-SW	



SINOMEMB®

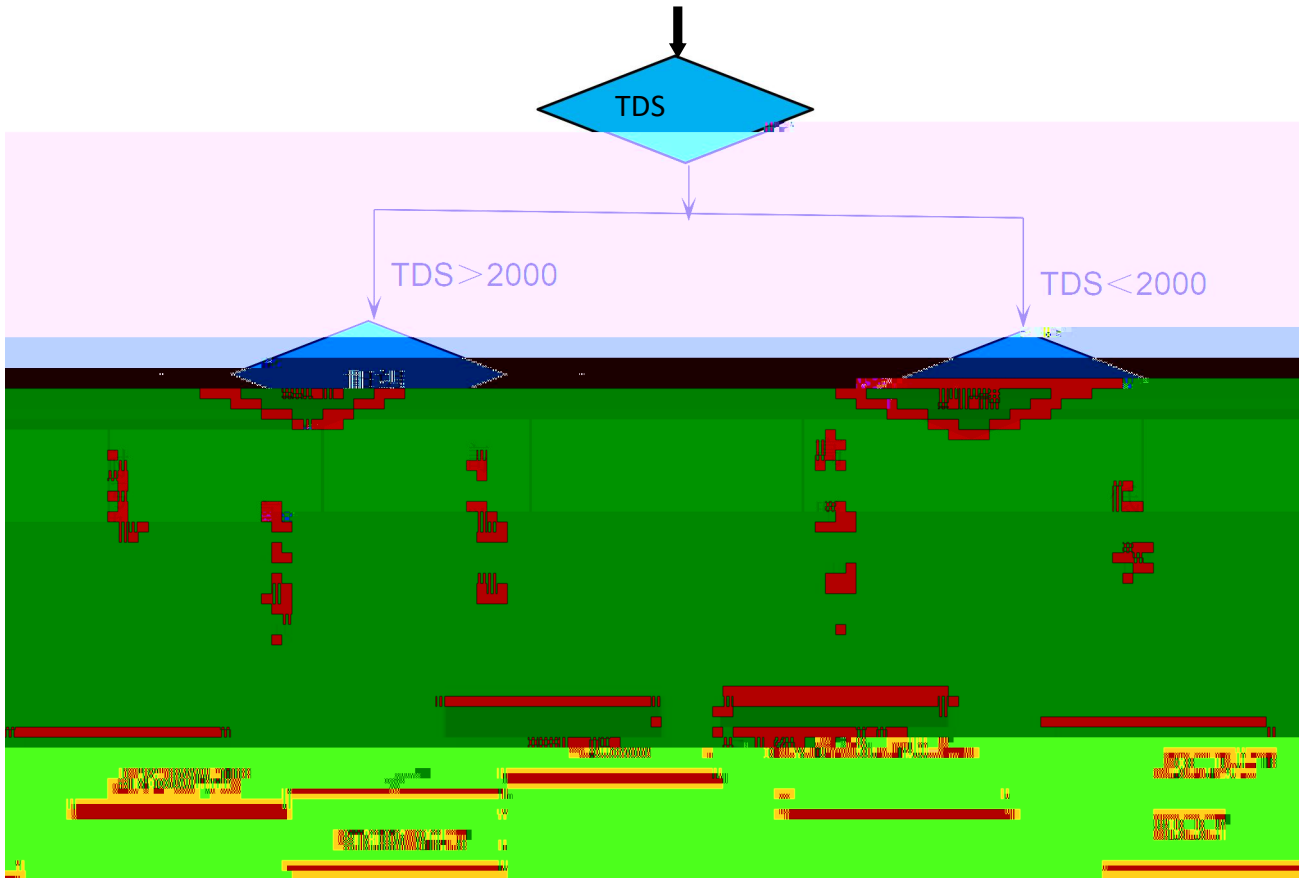

SNBW SNBW-HF							
SNBW-FR SNBW-XFR							
SNLE-FR				SNSW SNSW-HF			
SNLE-HF				SNHW			

TDS ppm



SINOMEMB®

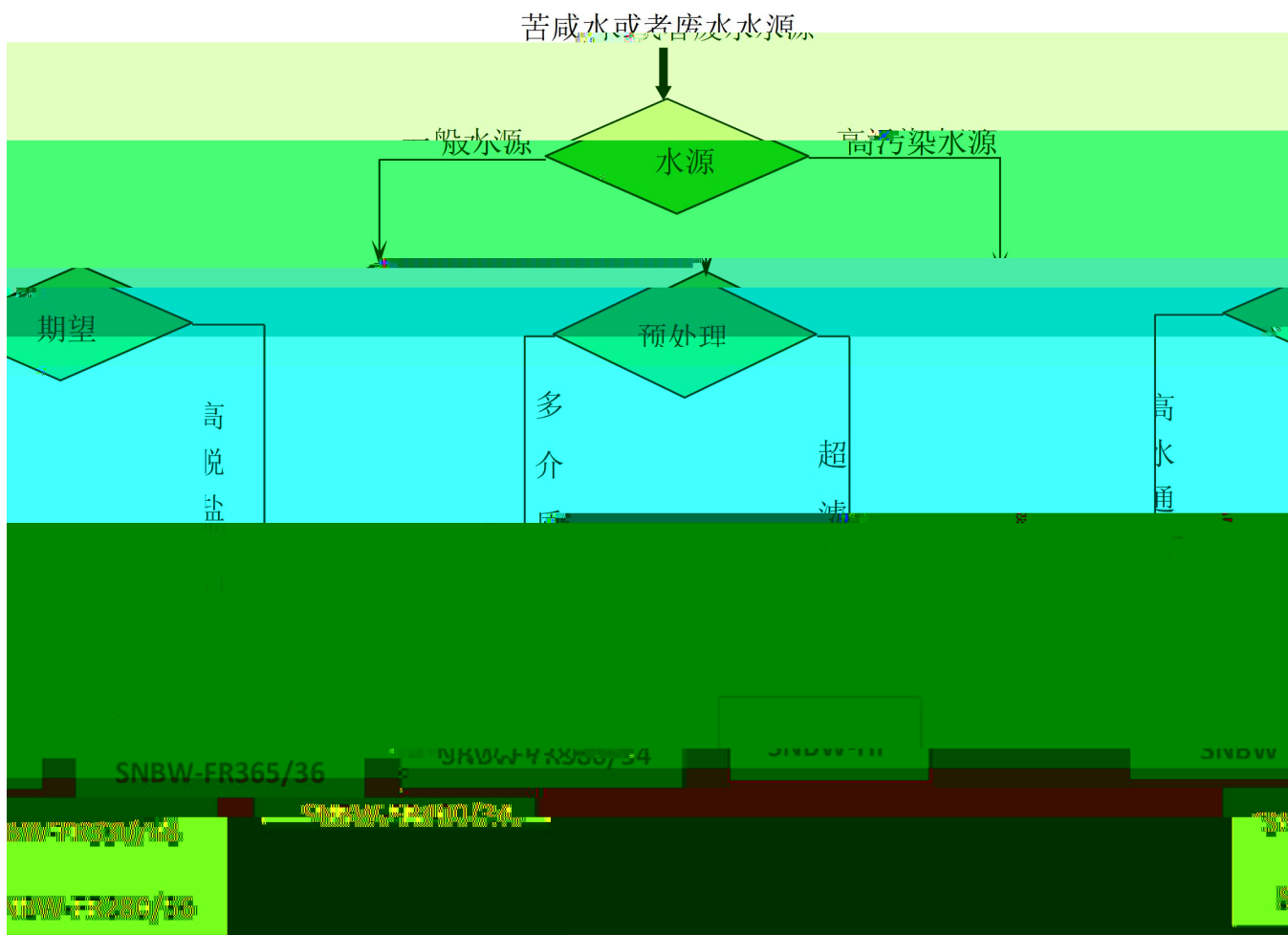



VIII. SINOMEMB®

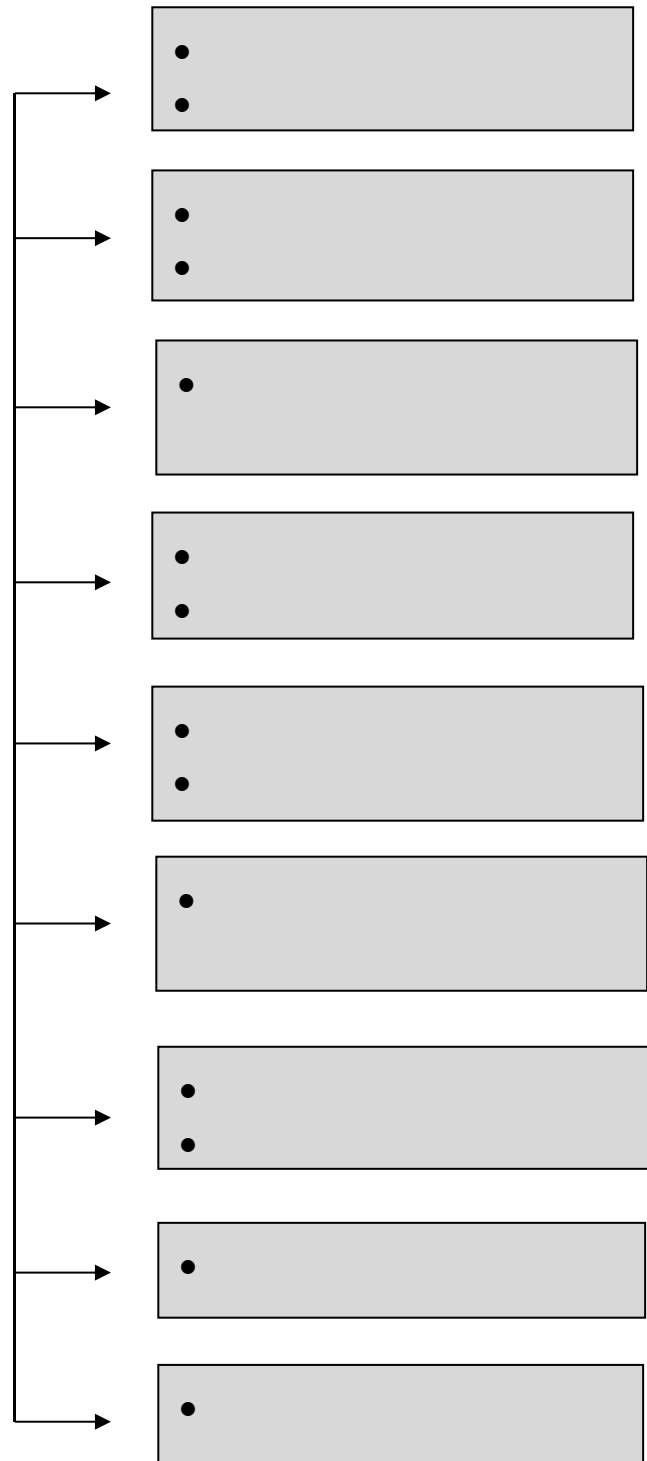



SINOMEMB®

SNLE

1.1

	ft ² (m ²)	GPD(m ³ /d)	(%)	(%)

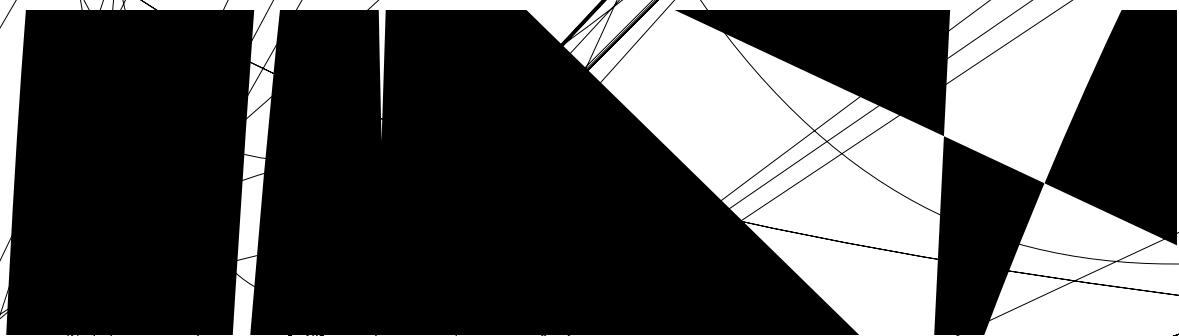





2.1

2.2

	ft² (m²)	GPD(m³/d)	(%)	(%)

2.3

2.4





SINOMEMB®

SNBW-FR

3.1

3.2

	ft ² (m ²)	GPD(m ³ /d)	(%)	(%)

3.3



3.4

3.5

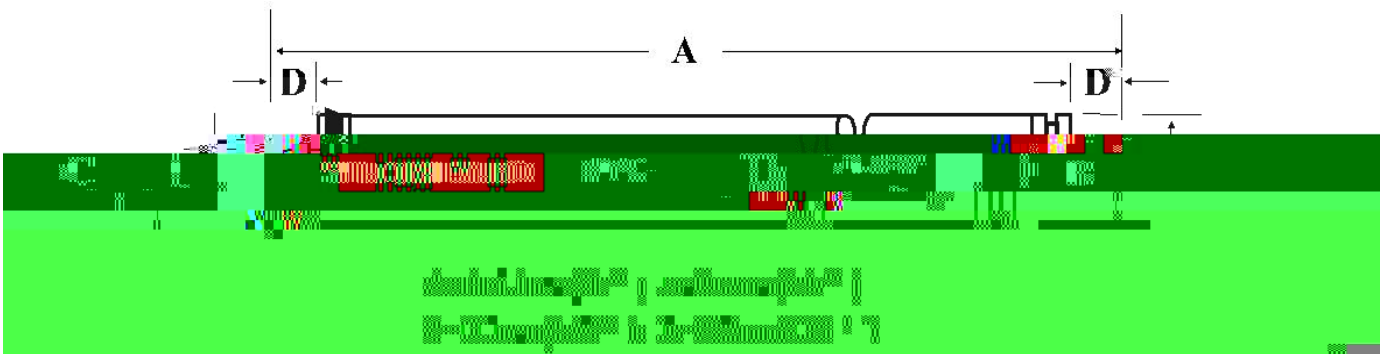
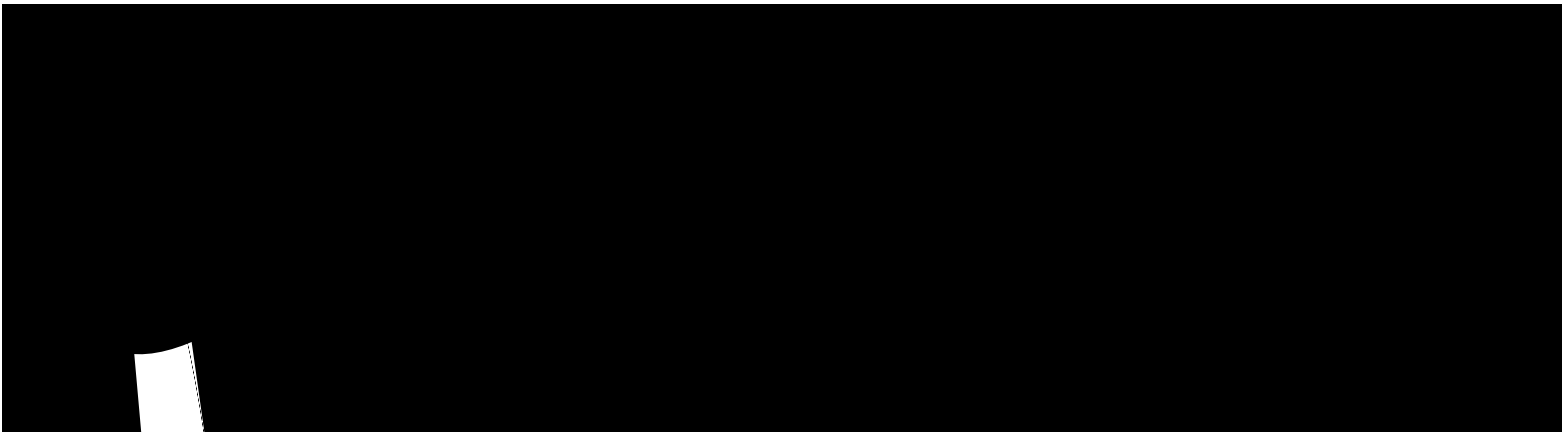









SINOMEMB®

SNBW-440Pro

5.1

5.2

	ft²(m²)	GPD(m³/d)	(%)	(%)

5.3

5.4



润泽天下 中国
Nourishing The World With Peace



SINOMEMB®

SNHW

6.1

ft² (m²)

GPD(m³/d)

(%)

(%)





●

●

7.1

7.2

ft²(m²)

GPD(m³/d)

(%)







®

8.1

8.2

	ft²(m²)	GPD(m³/d)	(%)	(%)	%
--	--------------------------------------	-----------------------------	------------	------------	----------



8.4

8.5

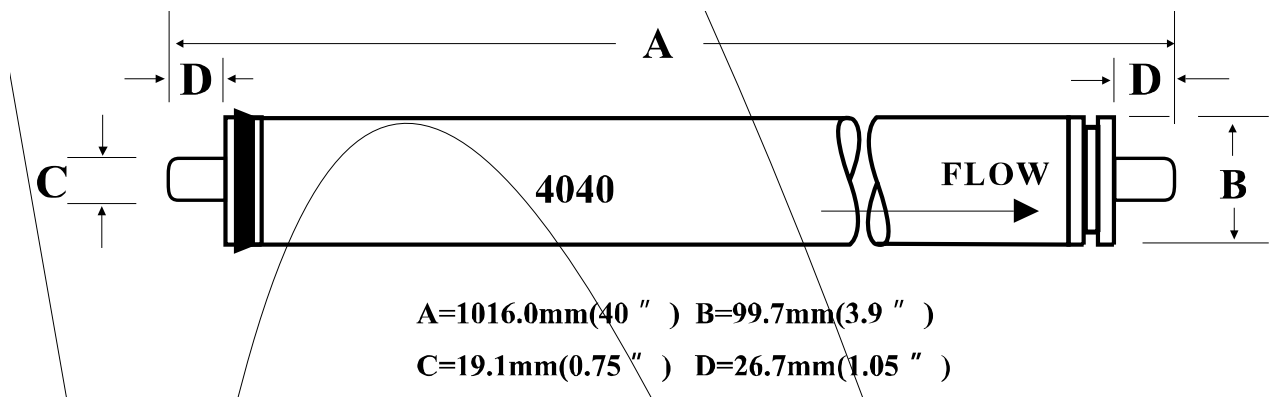







1.3

1.4



1.5

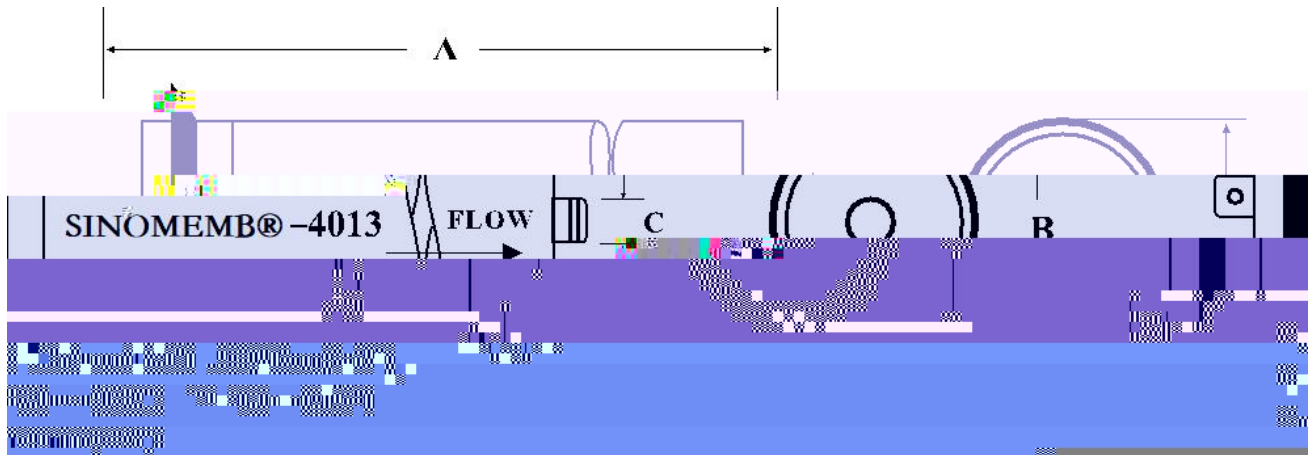
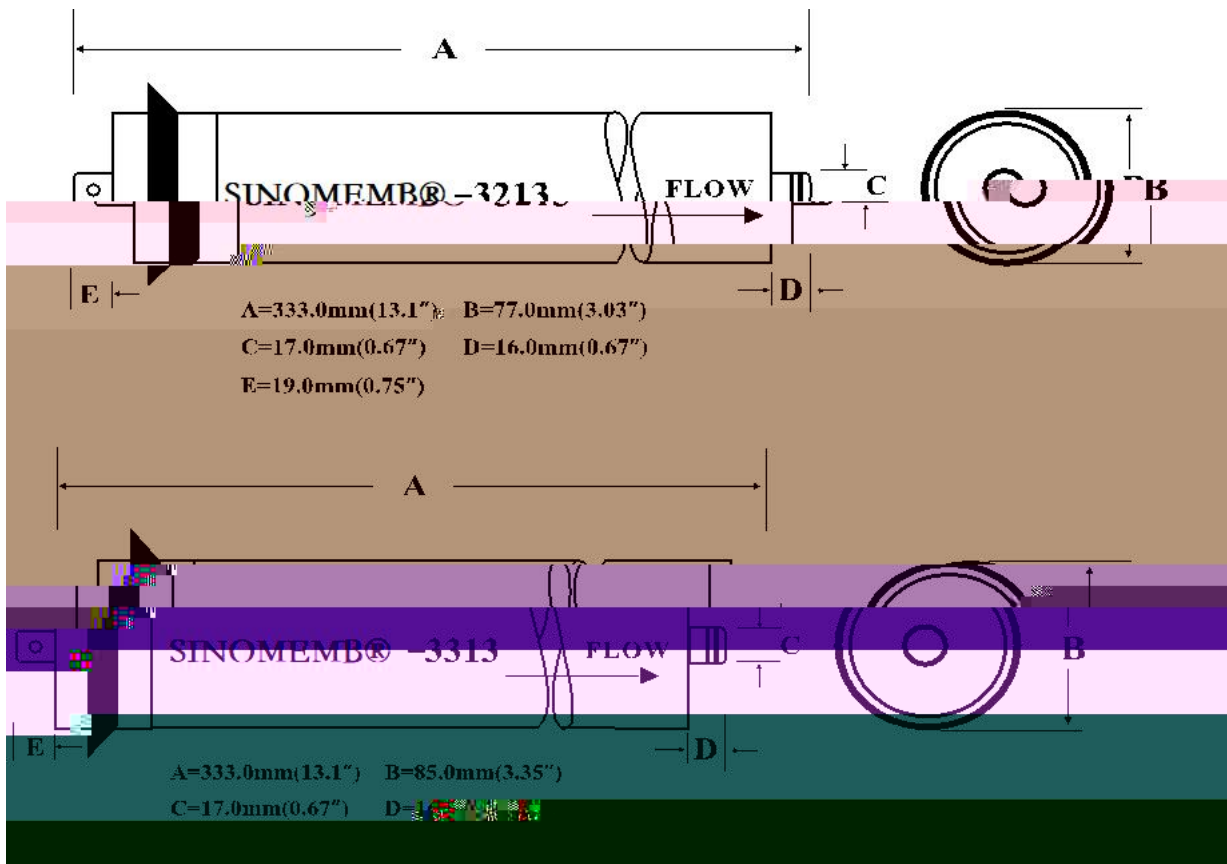

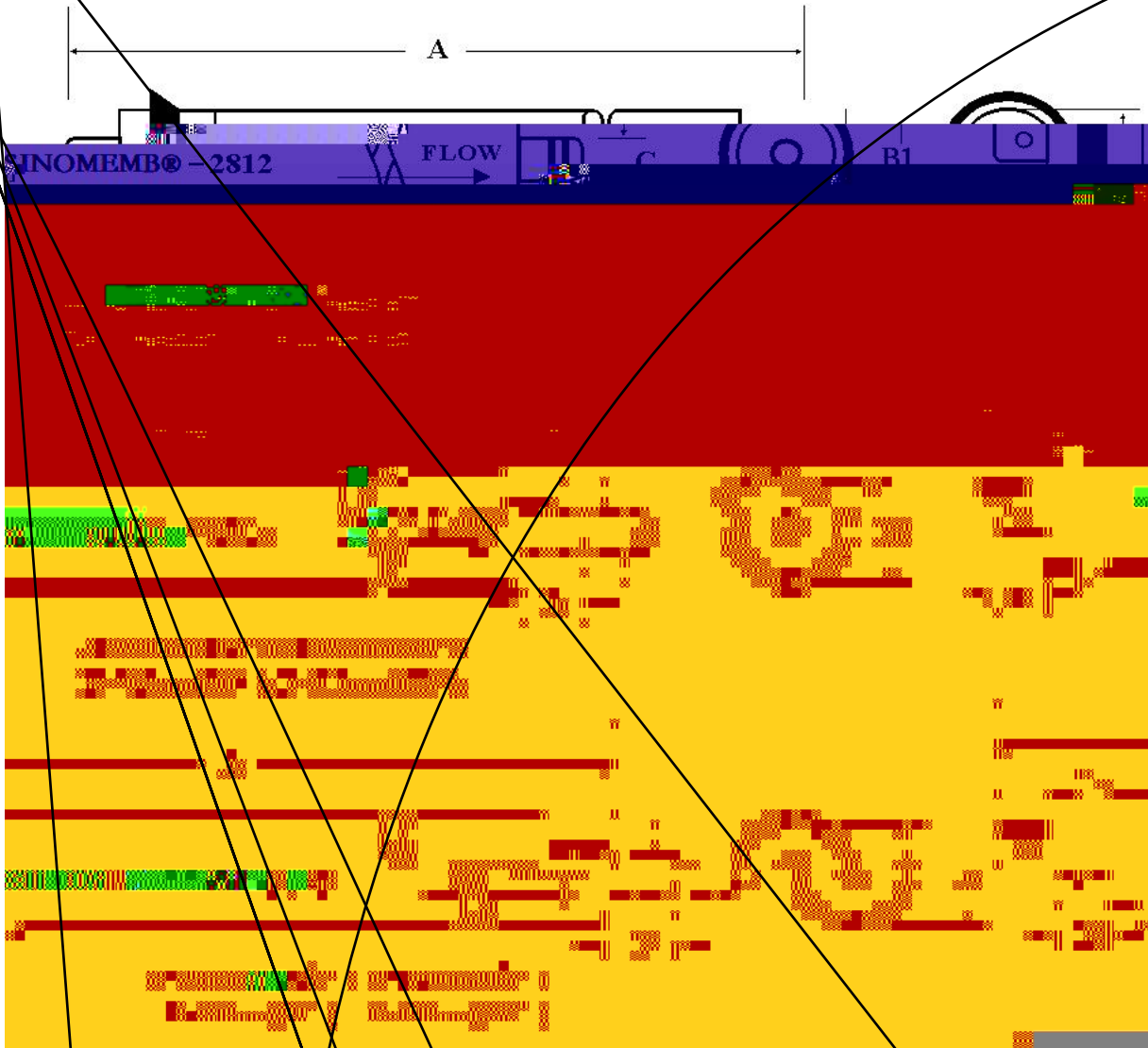





SINOMEMB®

SNSE

2.1

	(%)	GPD (m ³ /d)	psi(MPa)	(ppm)	(%)

2.2

2.3

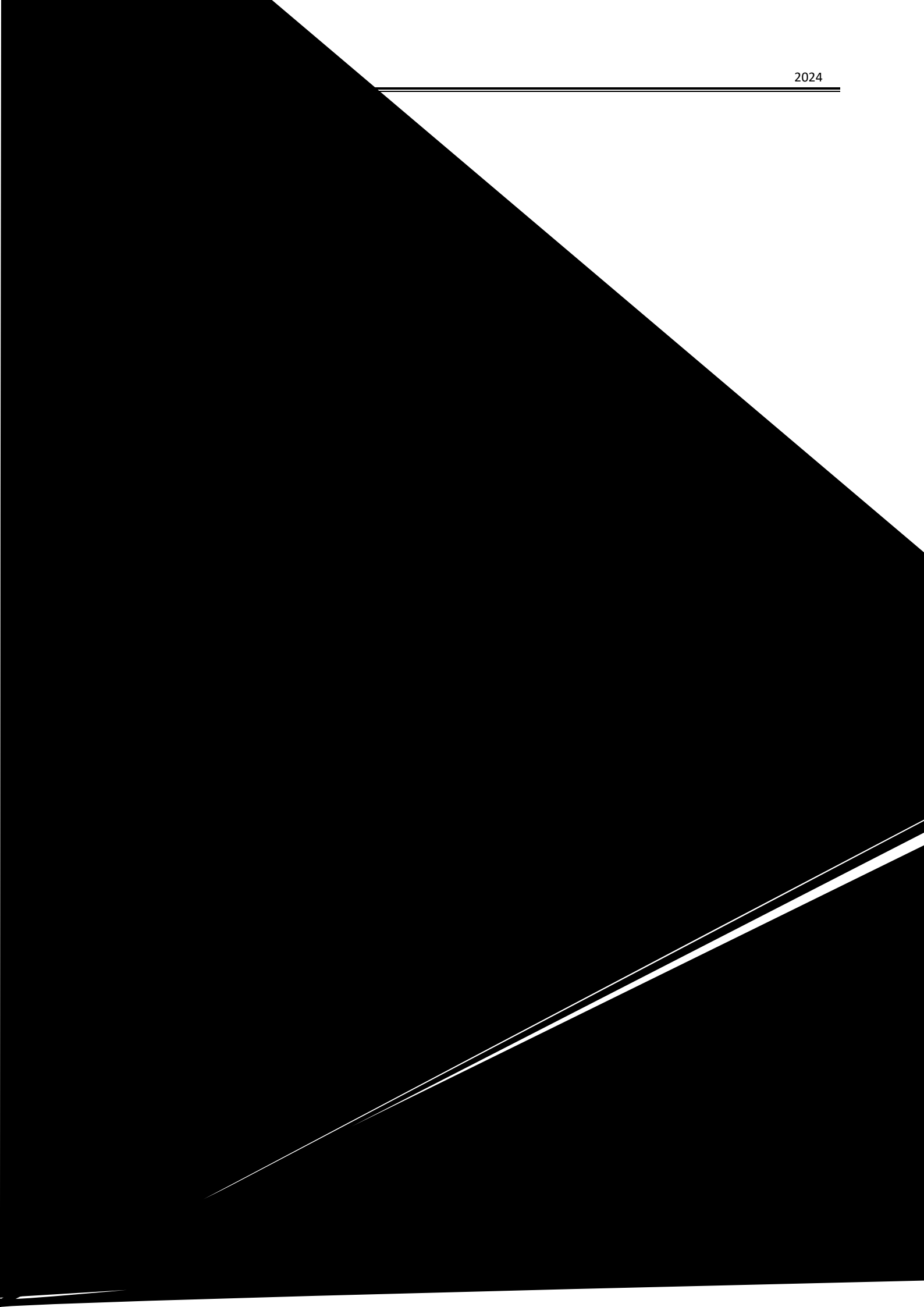





SINOMEMB® SNLE

3.1

3.2

	(%)	GPD (m ³ /d)			
			psi(MPa)	(ppm)	(%)

3.3

3.4



润泽天下 中国良芯
Nourishing The World With Pure Water

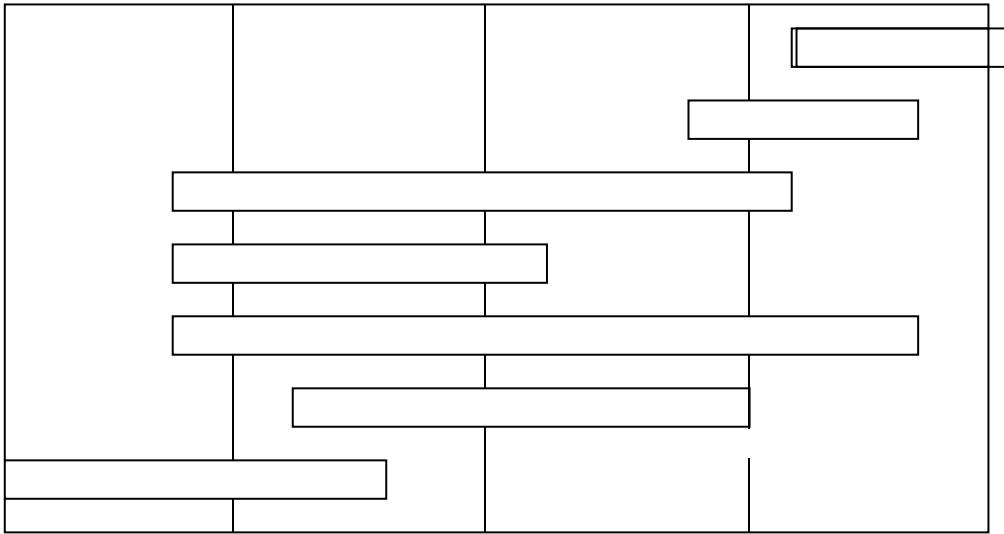



.3

F7\$G0à

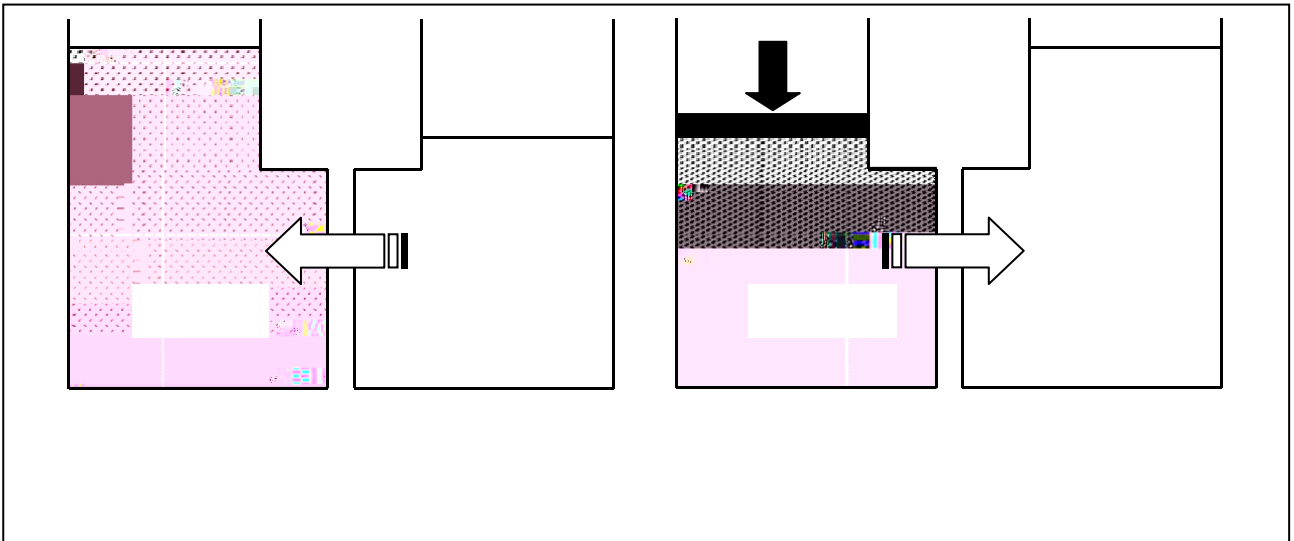

Q





3.5.1

3.5.2



润泽天下 中国良芯
Nourishing The World With Pure Water



∅



e

g

& É



		cr	





4.3

4.3.1







4.4.1





4.5

4.5.1



4.5.2



4.6

4.7

4.8



5.1

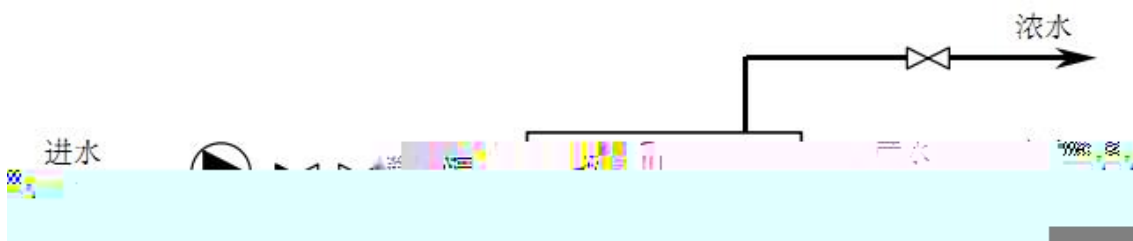
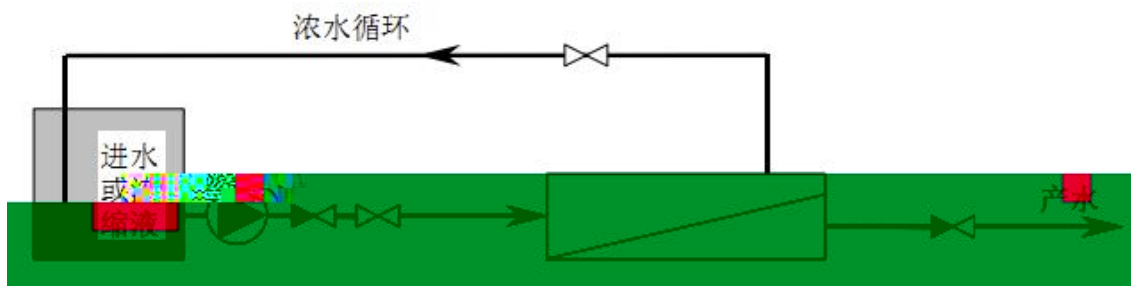



5.2

5.2.1

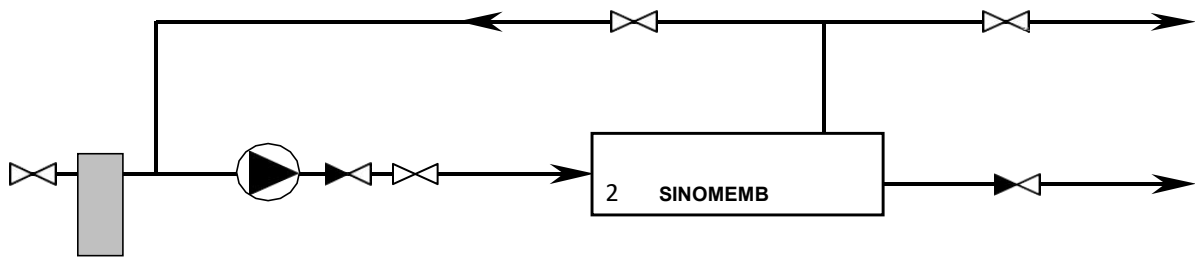



5.2.2

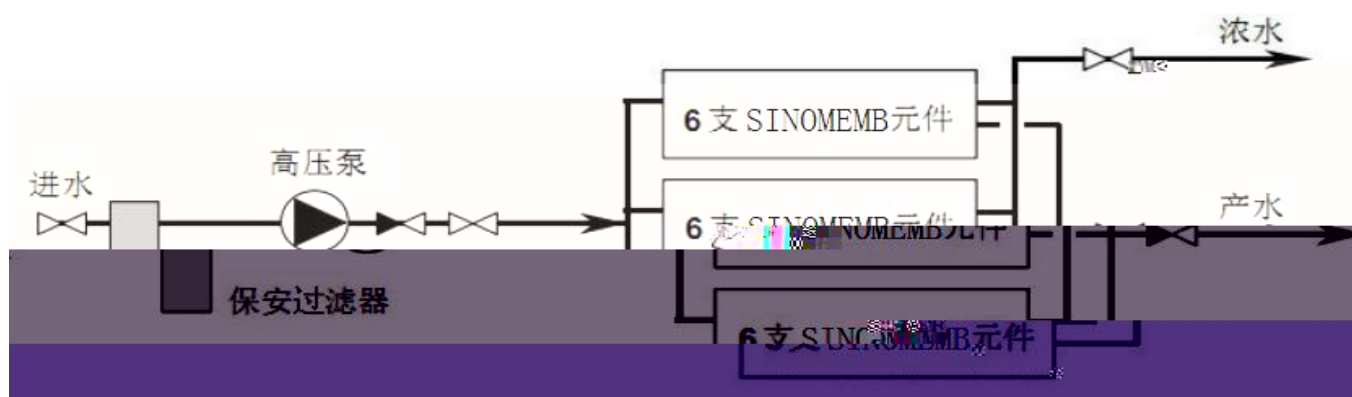

5.2.3

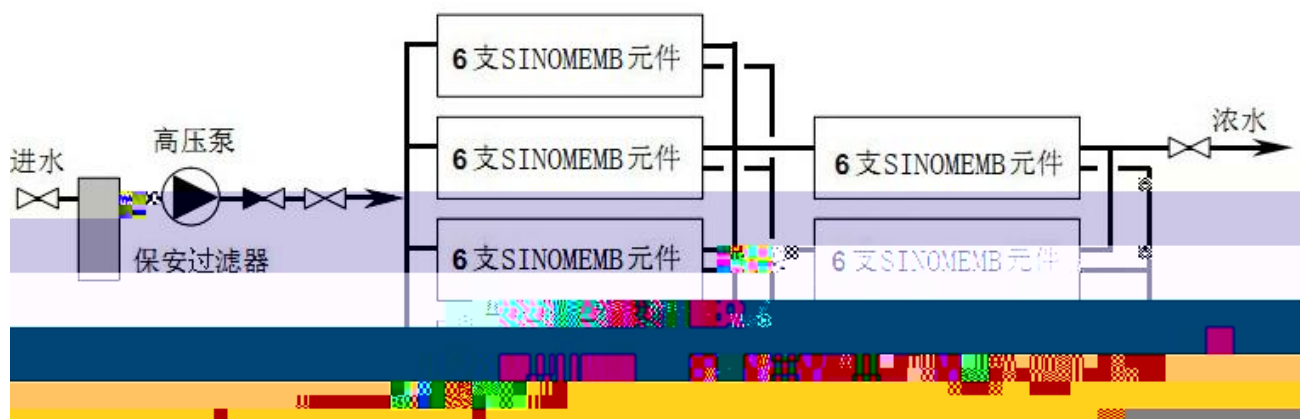

5.2.4

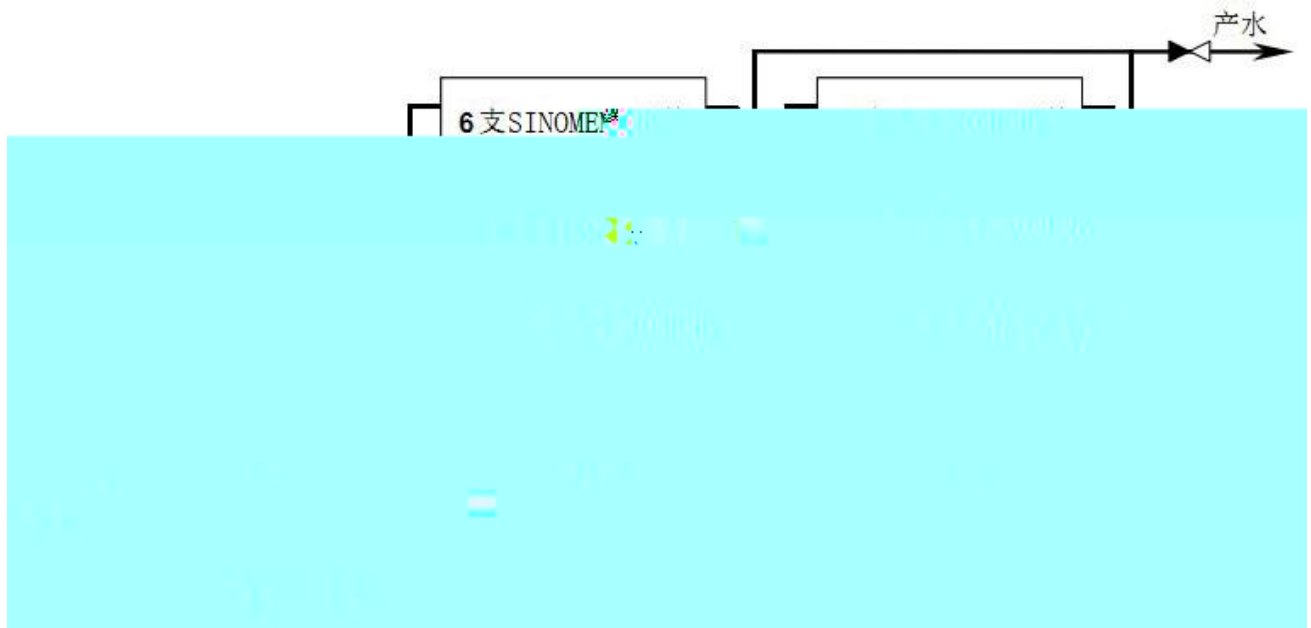

5.2.5

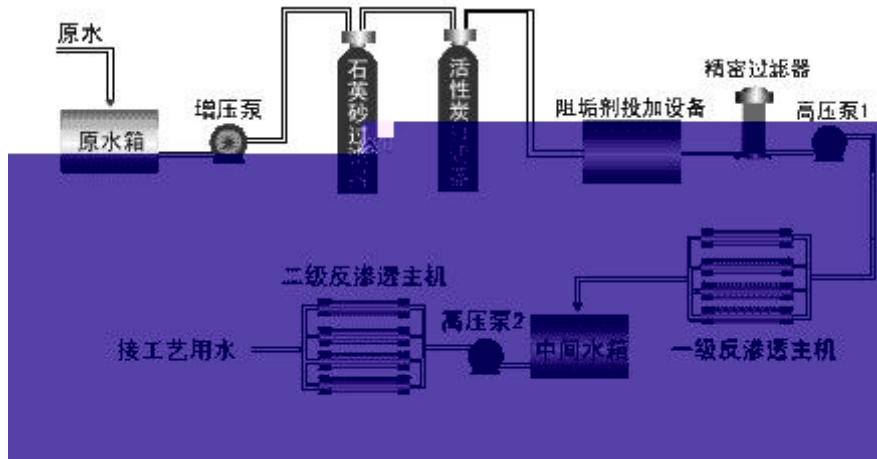

5.2.6



5.3.2

5.3.3

5.3.4

3.3.

$$\frac{=}{\times}$$



5.4 SINOMEMB®

5.5

5.5.1

5.5.2

5.5.3

5.5.4



5.5.5

5.5.6

5.5.7

5.5.8



5.6



6.1

6.1.1

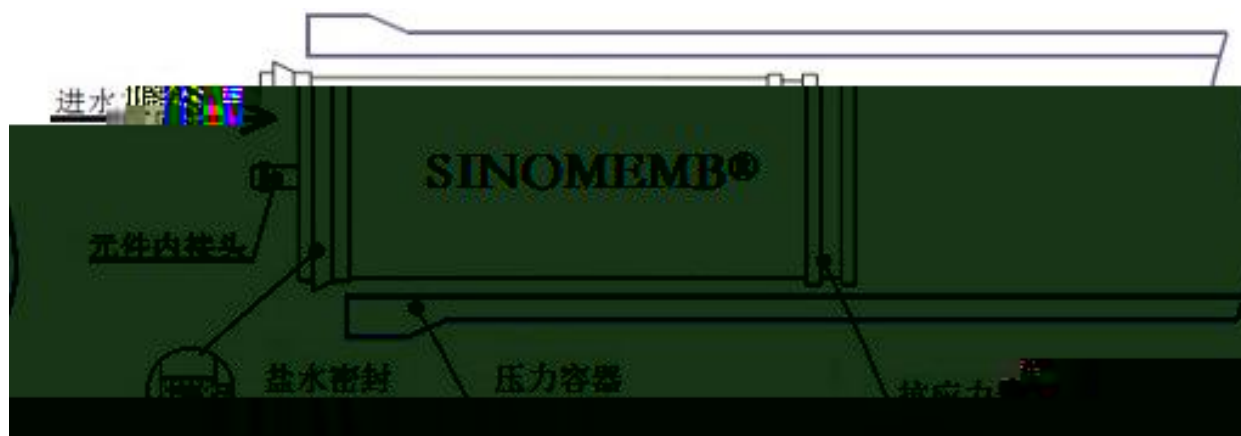

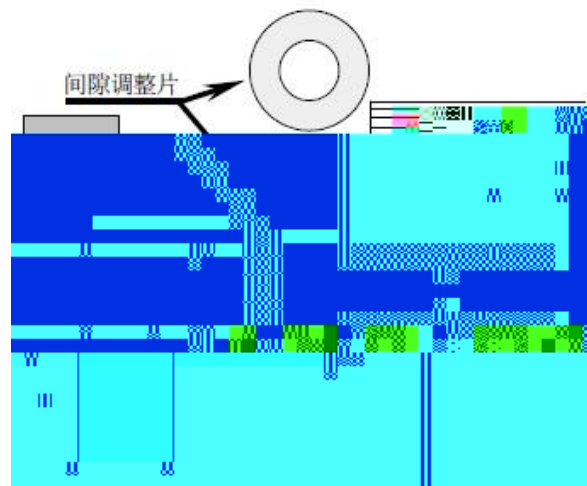
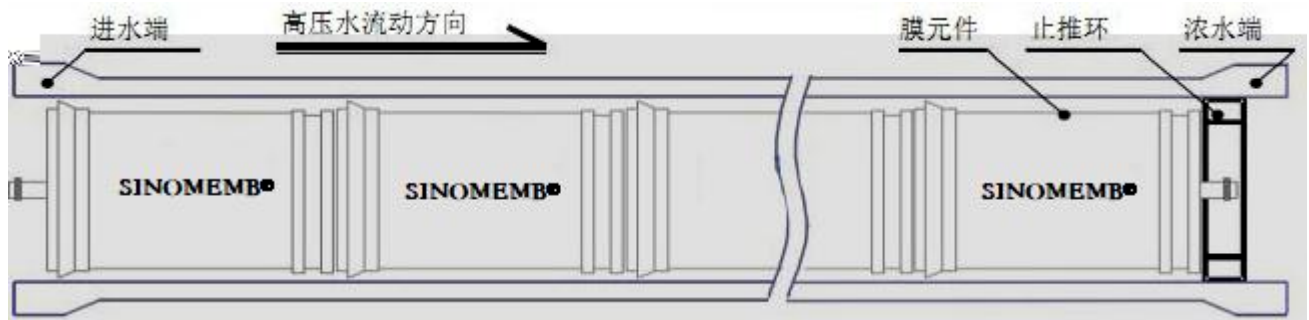



6.1.3

6.2

6.2.1

6.2.2

6.2.3

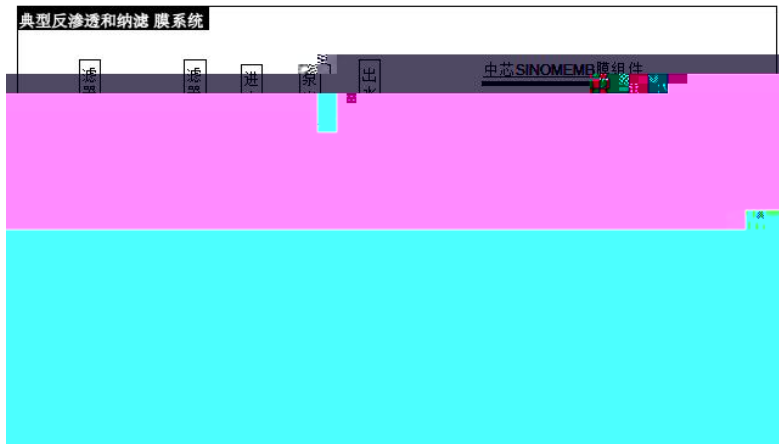



6.2.4

6.2.5

6.2.5.1

6.2.5.2



6.2.5.3



◇

◇

◇

6.2.7

6.3

6.3.1

6.3.2



•
•

•
•
•
•

&



7.1 RO/NF



7.2



润泽天下 中国良芯
Nourishing The World With Pure Water



典型反渗透清洗系统工艺流程图

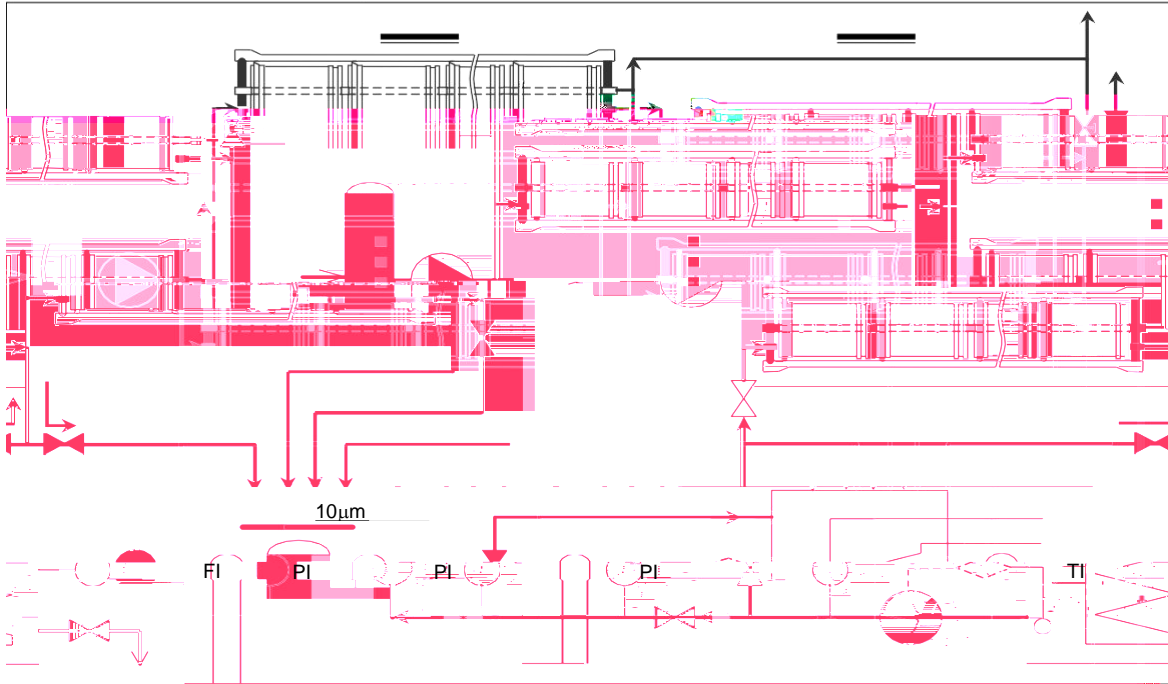

7.3



7.4

7.5

7.6







7.7



7.8



7.9





7.10

7.10.1

7.10.2



7.10.3

7.10.4

7.10.5



8.1

8.2

8.2.1

(1)

±

(2)



(3)

(4)

(5)

(6)

(7)

(8)

(9)

(10)

(11)

(12)

8.2.4





8.3

8.3.1

1

2

3



8.3.2

8.3.2.1

8.3.2.2



8.3.3



8.4



SINOMEMB®

9.1

®

9.1.1

9.1.2

9.1.3

9.1.4

9.1.5

9.2





SINOMEMB®

TFC



